

Pallas[®]

COMMERCIAL & DOMESTIC RO

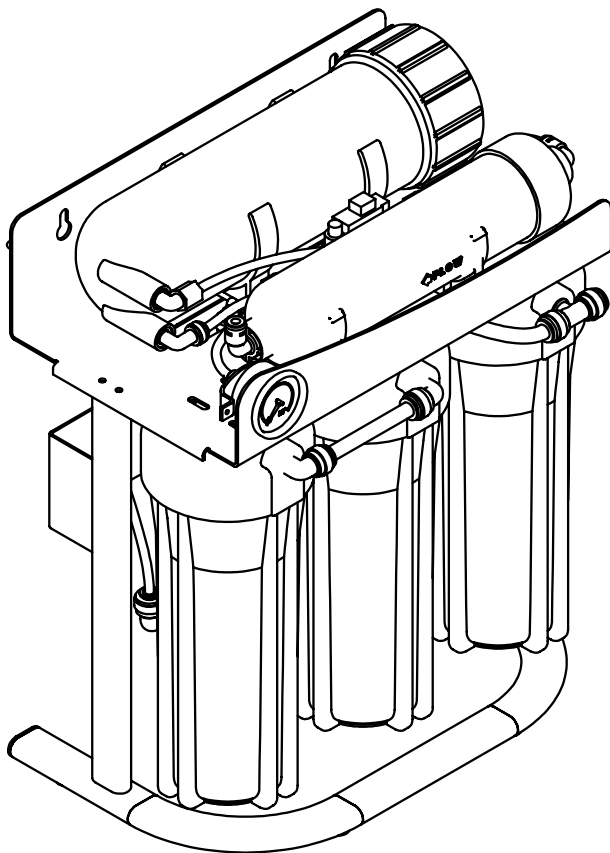

PALLAS
EF500
MANUAL

DEAR CUSTOMER,

Water Treatment Systems use Reverse Osmosis System which is one of the advanced technologies in the world.

Water Treatment Systems have been designed to remove physical, chemical and microbiological pollutants in water and to produce water in drinkable quality.

Water Treatment Systems not only produce drinkable water but also produce water in best quality for meeting the needs of domestic consumption. It helps you enjoy real taste of food and drinks.

Water Treatment Systems provide safe water for you to lead a healthy life. The product is manufactured in modern facilities without giving no harm to environment. It is recommended that you read the manual very carefully before using the product, which is manufactured studiously in.

“Thank you for choosing our product.”



DEFINITIONS OF SYMBOLS USED IN MANUAL



Important information and recommendations about using device



Risk of fire



Electric shock warning



Warnings against dangers of safety of life and property



Hot surface warning

PACKAGING INFORMATION



Packing materials are manufactured from recyclable materials by national regulation. Packing waste should not be disposed of with domestic and other waste. Please collect packing wastes at waste collection centres.



CONTENTS

GENERAL INFORMATION	4
PURIFICATION STAGES IN UNDERCOUNTER REVERSE OSMOSIS SYSTEM	5
WORKING PRINCIPLE	5
POINTS TO BE CONSIDERED BEFORE INSTALLATION OF THE DEVICE	6
BOX CONTENTS AND ASSEMBLY PARTS	7
DEVICE PROPERTIES	8
INSTALLATION AND ASSEMBLY	9
MAINTENANCE AND CLEANING	11
START-UP AFTER MAINTENANCE.....	14
WARRANTY CONDITIONS	15
IMPORTANT SAFETY AND ENVIRONMENTAL INSTRUCTIONS & CONSUMER RIGHTS	16
TROUBLESHOOTING.....	17
FREQUENTLY ASKED QUESTIONS	18
AUTHORIZED SERVICES AND SPARE PARTS SUPPLIERS.....	18

What is REVERSE OSMOSIS?

Osmosis is a process in which water passes through a semi-permeable membrane from a less concentrated solution into a more concentrated one. In naturally occurring osmosis process, reverse osmosis is achieved by pressurizing to higher concentrated environment. If higher concentrated environment is pressurized, water passes through lower concentrated one.

Semi-permeable membranes used in reverse osmosis systems are in pore diameter of 8-12 angstroms. Water molecules are smaller than 8-12 angstroms and have a neutral electric charge. For this reason, water molecules can easily pass through the membranes. However, positively and negatively charged ions and molecules in the water, bacteria and viruses cannot pass through the membranes because they are bigger than 12 angstroms and flow to the drainage.

As a summary, reverse osmosis is the most ideal water treatment method for ion removal by advanced filtration. Reverse osmosis method is one of the rapidly progressing technologies.

Design of the reverse osmosis system requires various technical knowledge and experience such as product water quality, raw water analysis, type of membrane etc.

Reverse osmosis practices

Water treatment device is designed to work with minimum water pressure. It does not require chemical use and produces quality water. It is manufactured as a compact device that can easily be installed anywhere thanks to minimum dimensions.

RO treatment device enhances taste and quality of your water. It decreases odor and sediment whilst minimizing chlorine up to 99%. Reverse osmosis device also decreases contaminants such as lead, copper, barium, chromium, mercury, sodium, cadmium, fluoride, nitrite, nitrate and selenium which may be present in water.

Water treatment devices will serve you for many years economically and efficiently as long as they are used according to the installation and assembly instructions and technical specifications described in this manual.

This device shall only be used in accordance with the design purpose and technical specifications described in brochure and the users manual. Maintenance and repair must be performed in accordance with the instructions in the users manual and original parts supplied by an authorized service must be used.

GENERAL INFORMATION

ION REMOVAL IN REVERSE OSMOSIS

ION AND ORG. PESTICIDE	REMOVAL (%)	ION AND ORG. PESTICIDE	REMOVAL (%)
Aluminium	97-98	Nickel	97-99
Ammonium	85-95	Nitrate	93-96
Arsenic	94-96	Phosphate	99+
Magnesium	96-98	Potassium	92
Bicarbonate	95-96	Radioactivity	95-98
Bromide	93-96	Radium	97
Cadmium	96-98	Selenium	97
Calcium	96-98	Silica	85-90
Chloride	94-95	Silver	95-97
Chromate	90-98	Sodium	92-98
Chromium	96-98	Sulfate	99+
Copper	97-99	Zinc	98-99
Cyanide	90-95	Boron	50-70
Fluoride	94-96	Borate	30-50
Iron	98-99	Mercury	96-98
Lead	96-98	Bacteria	99+
Mangan	96-98	Virus	99+

WORKING PRINCIPLE

STAGES OF CLEAN WATER PRODUCTION IN REVERSE OSMOSIS SYSTEM

Feed water pressure must be minimum 3 bar for reverse osmosis system to work. If the feed water pressure is not sufficient, the system can be reinforced with a pump. Feed water passes through the following filtrations respectively;

- 1st Stage: 5 micron pp sediment filter. The pre-sediment filter retains suspended materials and particles in the water and protects successive filtrations, especially the membrane filter. (1 mm=1000 micron).
- 2nd Stage: Activated carbon filter removes pollutants, which are harmful to human health and membrane filter, by retaining organic substances and high amounts of cancerogenic chlorine and chlorine compounds.
- 3rd stage: Block carbon filter is used for more sensitive particle filtration to retain the suspended materials in the water.
- 4th stage: Membrane filter. The semi-permeable membrane with 8-12 angstrom pores retains bacteria, viruses and heavy metals in the water at 95-98% and pollutant runs to the drainage through wastewater part of membrane.
- 5th stage: Last carbon filter (post carbon). Water runs through the carbon filter at the last stage to provide clean and extremely safe drinking water.

POINTS TO BE CONSIDERED BEFORE INSTALLATION OF THE DEVICE

Water treatment system's operating water temperature is between minimum 5°C (41°F) and maximum 40°C (104°F). It has risk of freezing to operate the device below 5°C as it carries risk of damage to filters when operated at above 40°C.

It is necessary to select a suitable location first for installation of water treatment device. It must be considered during selection that installation place should be close to cold water line of the RO device and to the drainage and sufficient space should be left for working in case of malfunction and filter replacement.

Water treatment device is designed for water with specifications close to tap water, whose inlet conductivity is max. 600 ppm and the turbidity is max 3 NTU. If raw water source and specifications are unknown, the raw water should be sent for analysis before installation of the device in order to check the suitability.

If the device is used beyond the limit values mentioned in technical specification part of the users' manual, the requested quality will not be achieved for product water. Usage of such feed water will cause variation in replacement periods of filters and membrane.

Inlet pressure is between 3 - 6 bar for water treatment devices without pump and between 1 - 6 bar for water treatment devices with pump. The optimum working pressure is 3 bar. In case the inlet pressure is above 4 bar, it is recommended to install a pressure reducer to prevent more wastewater discharge. Do not connect the device to power socket before it is installed. Our company will not be liable for any problems caused by non-observance of the above warnings.

TREATMENT DEVICE FLOW SCHEME

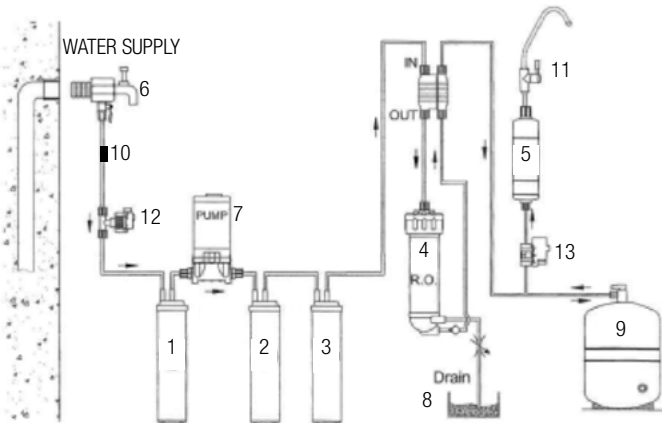

- | | | |
|--------------------------|----------------------|--------------------------|
| 1. PRE-FILTER | 4. RAW WATER | 6. FAUCET |
| 2. FIRST CARBON | 7. PUMP | 12. LOW PRESSURE SWITCH |
| 3. SEDIMENT FILTER / CTO | 8. WASTEWATER | 13. HIGH PRESSURE SWITCH |
| 4. R.O (50-100 GPD) | 9. STORAGE TANK | |
| 5. SECOND CARBON | 10. PRESSURE REDUCER | |

MANUAL BOX CONTENTS AND ASSEMBLY PARTS

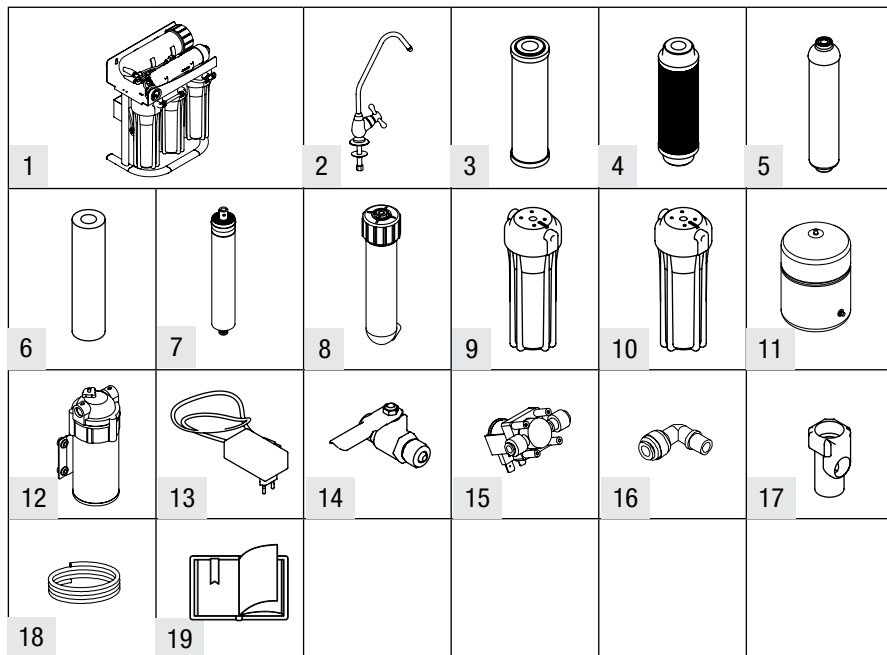

- | | |
|--|--|
| 1. Reverse Osmosis Device | 11. Metal Pressured Tank |
| 2. Faucet | 12. PUMP |
| 3. Block Carbon Cartridge Filter (CTO) | 13. Adapter |
| 4. Gac Carbon Cartridge Filter (UDF) | 14. Metal Ball Valve |
| 5. Inline Coconut Post Carbon Filter | 15. Selenoid Valve |
| 6. Spun (Sediment) Filter | 16. Quick Connection |
| 7. 500 GPD Membrane | 17. Feed water connection adapter |
| 8. Membrane Housing | 18. Hose |
| 9. Transparent Housing | 19. Users manual and certificate of warranty |
| 10. White Housing | |



TOOLS REQUIRED FOR INSTALLATION (not included in the box)

* Drill bits, steel or diamond drill bits set 12 and 13 mm tip and herringbone files (rasp). You must use the tools according to the installation place or ground.

* Teflon tape.

* Wrench (frog key or required open mouth key set).

* A sharp knife or craft knife.

DEVICE PROPERTIES

TECHNICAL SPECIFICATIONS

Min. Operating Water Temperature	5 °C
Max. Operating Water Temperature	40 °C
Min. Inlet Pressure	100.000 pascals
Max. Inlet Pressure	600.000 pascals
Max. Inlet TDS (ppm)	600 ppm
Max. Inlet Water SDI	3
Inlet Diameter	8 - 10 mm

ELECTRICAL DIAGRAM (DEVICES WITH PUMP)

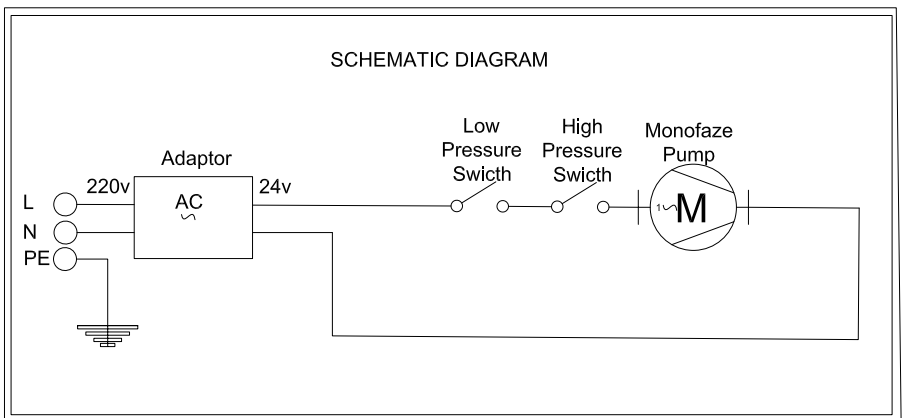

i NOTE: The equipments used in the product are in compliance with Water Quality, CE and NSF standards. The equipments are certified.

i NOTE: Products without pressure reducer are not covered by the warranty.

MANUAL INSTALLATION AND ASSEMBLY

HOW TO ASSEMBLE

SINGLE BATTERY WATER INTAKE

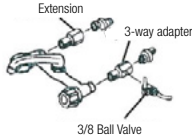

DOUBLE BATTERY WATER INTAKE

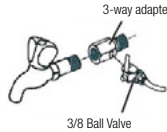

WATER INTAKE IN UNDER COUNTER

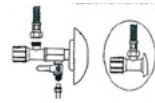

FIGURE A-2

1. Before the installation, turn off the valve of main feedwater line or the inlet valve.
2. After draining the remaining water in the pipes, install feedwater connection adapter (3-way adapter) by fastening with teflon band (Figure A- 2)
3. Install 3/8" metal ball valve on the feedwater connection adapter (3-way adapter) by means of teflon band so as to turn on/off easily (Figure A -3).
4. Install 6 mm water inlet tube to the 3/8 "metal ball valve. Note that the ball valve is closed.
5. Then, turn on the valve of main feedwater line or the inlet valve and check whether there is any leakage.

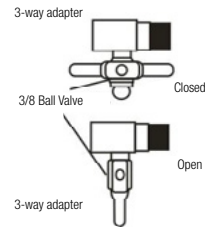

FIGURE A-3

MOUNTING THE FAUCET

1. In case of drilling countertop or sink, faucet for clean water must be installed carefully in terms of usage and aesthetics. You can start to drill countertop or sink after leaving enough space for installation of seal, nut and union at the bottom of countertop or sink. Otherwise, you may drill the wrong place.
2. If you drill marble, granite ceramic, laminate or sheet metal sink, first you should use 5 mm drilling bit and then 12 mm drilling bit, respectively. The drill must be operated at low speed and without impact. If the counter is covered with tile-coated cast concrete, it must be drilled with a diamond bit. (Figure A- 4)
3. Outer length of the faucet is 7 cm. If the counter is thicker than 7 cm, you'll need to use fittings as many as required. Finally, place the faucet into the hole, adjust its joints and tighten the nuts.
4. Filters should be washed before use to run out residues on them (check washing procedures page).

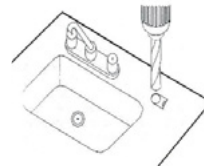

FIGURE A-4



FIGURE A-5

i The images in the manual may not be identical to each other.

i **NOTE:** If you do not want to drill the under counter sink and washbasin, you can also install it by using a single faucet. Contact your authorized service for replacement of the faucet adapter, which you have used, with the three-way one through which hot, cold and purified water flow (Extra charge for the faucet).

MANUAL INSTALLATION AND ASSEMBLY

MEMBRANE INSTALLATION

- 10" Inline 5 Micron Spun (Sediment) Filter
 - 10" Inline Gac Carbon Cartridge Filter (JDF)
 - 10" Inline Block Carbon Cartridge Filter (CTO)
 - 500 GPD Membran
 - 10" Inline Coconut Post Carbon Filter
-
- After installing the filters, unscrew membrane housing cap. Insert the membrane into the housing until it stops. Then, screw the housing cap.
 - Cut the tube to a length that will allow to connect the post carbon filter outlet to the faucet after mounting the faucet and drain line.
 - Loosen and pull out stem-nut on outlet of the post carbon filter. Put the nut on tube and tighten firmly. Insert the other side of the tube into respectively yellow nut and collet placed under the faucet. Push the tube to the faucet and tighten the nut firmly.

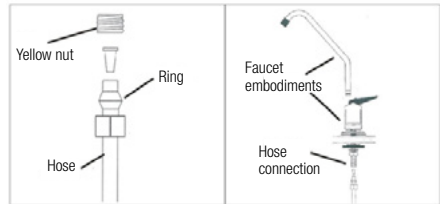

HOSE CONNECTION SCHEME

As shown in figure;

- A: Water inlet
- B: Product water tube is connected to RO faucet.
- C: The tube at the outlet of post carbon is connected to product water line.
- D: The drain tube is connected to wastewater outflow line.

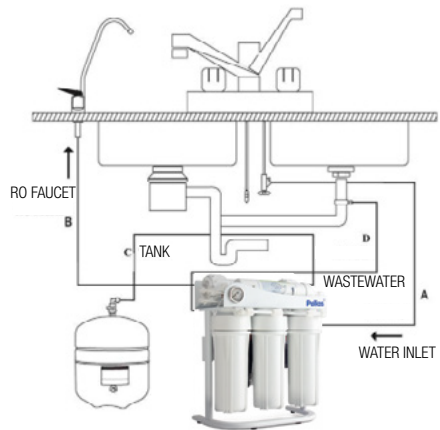

MANUAL INSTALLATION AND ASSEMBLY

START-UP AFTER INSTALLATION

Once you have assembled and installed all the components, turn on the water supply first to check for leaks. Then, turn on the faucet slowly. At the first stage, water will run from the faucet slowly. Let it run in this way for 10 minutes. If the water starts to drip and do not reach normal flowrate, it probably means that the water pressure is so low that the device cannot perform with 100 % efficiency. If you are experiencing such a problem, see Troubleshooting on page 17.

Now your device is ready for usage, you can enjoy quality water safely.

i !! IMPORTANT !!

**During the first few days after installation, air bubbles may be seen in the water.*

**Water treatment device will work better and longer when it is used more often. For this reason, we recommend you use the purified water for cooking, preparing tea, coffee etc.*

**In case of water leaks, broken filters etc., turn off the valve of water supply and correct the faults.*

MAINTENANCE AND CLEANING

REPLACEMENT PERIODS OF CARTRIDGE FILTERS

Spun (Sediment) Filter:

It should be replaced approximately every 6 months depending on the water contamination.

GAC Carbon Cartridge Filter (UDF):

If the water is clear and the total amount of chlorine is low, the cartridge life is 6 months on average.

Block Carbon Cartridge Filter (CTO):

The cartridge life is approximately 6 months depending on the amount of chlorine in the water and replacement periods of pre-filters.

Membrane Filter:

The membrane life is approximately 3 years depending on the regular maintenance.

Coconut Post Carbon Filter:

The cartridge life is approximately 12 months.

If feeding tube is damaged, it should be replaced with a specially prepared tube or tube set supplied by the manufacturer or authorised service.

MAINTENANCE AND CLEANING

INSTALLATION AND REPLACEMENT OF MEMBRANE WASHING PROCEDURES

1. Disconnect the plug from the socket.
2. Turn off the water supply valve.
3. Turn the Jaco fittings clockwise.
4. Unscrew membrane housing's cap by turning it clockwise.
5. Grasp the membrane with a clamp and pull out.
6. Push new membrane carefully into the housing until it stops.

After installing the membrane, screw the cap and reinsert the tube in the same way. Open RO tap to clean the newly installed membrane filter. Let the system run for 2 hours and the water run out. Then, you can drink the purified water.

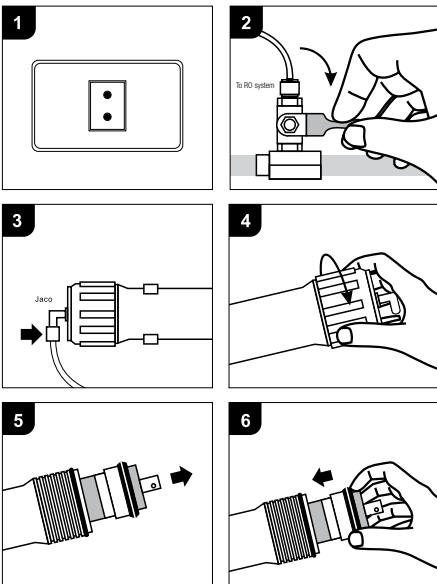

i The device can be used by the children, who are above 8 years old; physically, sentimentally or mentally disabled persons or people with lack of experience and knowledge on the condition that they are trained or instructed about safe usage of the device and have understood the hazards. The children must not play with the device. The maintenance must not be carried out by the children without observance of an adult.

You're kindly requested to follow washing procedure written below for operating your system at the highest performance.

1. Shut off the tank valve and turn on the purified water faucet. Insert the plug in the socket and turn on the ball valve (page 4, part number 9). The wastewater should be drained throughout a wastewater pipeline (it is proper to install to the drain pipe of the sink).
2. Sediment Filter and Activated Carbon Filter (1st and 2nd filter) are washed together. The foul water should be drained out before reaching Block Carbon (3rd filter). Once clear water is obtained, Block Carbon (3rd Filter) is washed with the water coming through 1st and 2nd filters and black water coming through block carbon should be drained out (4th and 5th, and 6th filter if available should not be fed with this water). Block Carbon (3rd filter) is washed for 10 minutes.
3. Post Carbon (5th filter) is washed with the water coming through the first three filters [before installation of membrane (4th filter)] and the water should be drained out. Once clear water is obtained, mineral of pH filter (6th filter), if available, is washed and this process is repeated until clear water gets.
4. The membrane (4th filter) is inserted into membrane housing in a way that the gaskets will be underneath (These gaskets should be placed in by getting wet and turning rightward) and the cap of housing is closed. The membrane is fed with water. This water should be drained out before reaching tank, post carbon and mineral filter if available. Until 8 litres of water is obtained from the membrane, the water should be drained out directly (It takes around 45 minutes).
5. Turn on tank valve and shut off the clean water faucet. The purified water should fill in the tank and it will take 45 minutes. At the end of 45 min., the tank should be filled and the water should be drained once at least by turning on purified water faucet.
6. You can drink safe and clean water at the end of these processes.

MAINTENANCE AND CLEANING

Membrane replacement and housing sanitisation as seen in figures;

- Open drinking water faucet.
- Loose the union of the membrane housing on the water inlet side and disconnect tubing from the housing.
- Unscrew the membrane housing from the cap (with pliers) and displace the used membrane.-Clean the membrane housing with disinfectant (bleach solution) and rinse the housing. Wet or wipe the O-ring at the bottom of the new membrane element for being seated properly. Push the membrane into the housing with o-ring side first. Ensure the membrane fit into the housing properly.
- Screw the cap back onto the membrane housing and tighten with hand or the supplied wrench.
- Finally, place the union at the water inlet side of the membrane properly and tighten firmly.

i The treatment device must not be supplied with hot water. Otherwise, all filters will be damaged and the device will be out of warranty.

i **!! ATTENTION !!**
The water first-supplied to the device should be discharged after passing through the filters. It should definitely not contact the tank and post carbon

i Do not forget to connect the power plug to the socket in models with pump.

REPLACEMENT OF POST CARBON FILTER

- Turn off the water supply and open drinking water faucet.
- Loose tubing unions at inlet and outlet and discard the used post-carbon.
- Disconnect the union placed at the outlet of the filter. To prevent leaks, apply teflon tape to the T-connector on water supply and install the filter.
- Tighten the tube unions.

Water Treatment Device is designed for easy installation and maintenance. It is essential not to exceed the recommended replacement periods of cartridge filters and to use the device properly. When the required maintenance and repair is not provided, the life span of the device is shortened and the efficiency of the membranes is reduced. Such situations may cause certificate of warranty to be void.

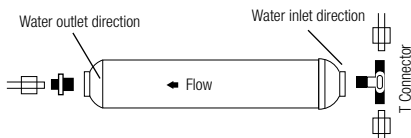

i **WARNING:** FLOW marking on the filter shows the direction of the water outlet. Ensure not to insert it backwards and do not over-tighten T-connector and the union on the other side.

SANITISING DEVICE

The water treatment device should be disinfected at least once a year as follows;

- Turn off the water supply.
- Drain all of the water from the tank by opening the faucet (for the models with tanks).
- Add a teaspoon of chlorine to the filter housing and screw back onto the cap.
- Turn on the water supply.
- Repeat this process for 2 times and replace all cartridge filters (for the models with tanks).

START-UP AFTER MAINTENANCE

PRECAUTIONS TO USE YOUR DEVICE LONGER;

To ensure that your device functions properly and to prolong the life of the device, the following points must be taken into consideration. Otherwise, the warranty will be voided.

- Do not use with water that has temperature above 40 °C.
- Place or fix the device on a flat surface.
- Do not touch the valves on the device except when necessary.
- It is recommended to install pressure reducer on water inlet of RO device when installation pressure is high. -Ensure that periodical maintenance is performed on time and by the authorized service.
- In case of long periods of non-use, turn off water supply. Follow start-up procedure when you want to re-operate.
- Keep your device clean by wiping with a wet cloth periodically and avoid using harsh and corrosive cleaners.

After turning on the valves, turn on the water supply. Open RO faucet and check the entire system for leaks.

Now you can enjoy the quality water safely.

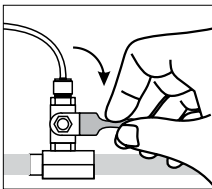

Turn on the mini valve of the water supply as shown in the figure.

TRANSPORTATION AND HANDLING

At first, follow the occupational safety rules.

- Drain the water in the tank before transportation and handling.
- Close the water supply of the tank and if the device model is with pump, disconnect the plug from the socket carefully.
- Demount the device carefully.
- Do not leave your device hanging from a higher place.
- Pay attention to keep the parts in the same place to avoid losing them.
- Keep the device in a dry and closed place.
- Pay attention not to drop, break, shake, crush the device during transportation and handling. Ensure that it does not get damaged due to heat, humidity or dust. Keep it out of sun exposure.
- You can get support from our authorized services to avoid unexpected damages during transportation and handling.

Supply of Spare Parts Under/Out of Warranty:

Warranty period is 2 (two) years from the date of your invoice. You can supply spare parts of this product for 10 (ten) years from the delivery date. The warranty is applicable only to defects in the device and we are not responsible for any other cost. No claim of indemnity can be made under any other name.

WARRANTY CONDITIONS

EXCLUSIONS FROM THIS WARRANTY

The warranty excludes defects caused by the misuse of water treatment device. The consumer should pay attention to the following points;

- Damage and defects caused by the misuse,
- Damage and defects during loading, handling and transportation after the delivery to the customer,
- Low or high voltage, damages and defects due to electrical faults,
- Defects resulting from failure to comply with instructions specified in the users manual,
- Replacements of membrane and filters are out of warranty. They are consumable elements.
- Warranty period of product is 2 (two) years in case of manufacturing defects.
- Exceeding minimum span for repair of the device.

Damages and defects resulting from the above-mentioned matters are not covered by the warranty and the service can be provided in return of a fee. The responsibility for handing over the warranty certificate to the consumer is of seller, dealer, agent or representative who sells the product.

In the event that the warranty certificate is tampered and altered, the warranty certificate will be invalid.

DAMAGES AND DEFECTS DUE TO THE MISUSE

- Loss of original parts of the device or demounting the parts contrary to the instructions.
- Damages and defects resulting from the factors such as crash, scratch, break etc.
- Damages and defects due to transportation and storage conditions.
- Damages and defects resulting from replacement or damage of electrical cable connections.
- Damages or defects resulting from paint or stain on any part of the product.
- Damages or defects due to sticking any label on the device.

- Damages or defects due to natural disasters.
- Damages or defects resulting from running the device with water below 5oC degrees and above 40oC degrees.
- Damages or defects due to electric networks.
- Damages or defects due to replacement of parts or materials in the device by any other parties which are not an authorized service.
- Damages or defects due to unknown material found inside the product.
- Problems resulting from failure to comply with installation, operation or maintenance instructions or drawings, or improper installation, operation or maintenance.
- Damages and defects resulting from using non-original spare parts and accessories.
- Damages and defects resulting from running the product without water or inadequate water.
- Damages and defects due to failure to perform periodical maintenance and controls.
- Damages and defects resulting from clogged wastewater drain and running the clogged device.



Defects that are not covered by the warranty will be repaired at our authorized service centers.



Warranty certificates without dealer's stamp and signature, sales date, brand and model are invalid. The original or photocopy of the invoice must be kept and submitted with the warranty certificate if necessary. Otherwise, the date of manufacture on the device will be deemed as beginning of warranty. The customer cannot claim rights or indemnity other than these undertakings.

IMPORTANT SAFETY AND ENVIRONMENTAL INSTRUCTIONS & CONSUMER RIGHTS

INFORMATION ON POTENTIAL HAZARDS FOR ENVIRONMENT AND HUMAN HEALTH DURING OPERATION

- Please note that the ground on which electrical devices are placed is dry and isolated.
- There is no important issue that will threaten the environment and human health during use.
- When life span of your device expires, send it to recycle.

LIFE SPAN OF THE DEVICE

The product has a service life of 10 (ten) years if you comply with the maintenance and operation instructions specified in the manual. Otherwise, life of the device may be shortened. As long as the device is not exposed to high temperatures and sun, you can use the device efficiently for many years.

INFORMATION OF EFFICIENT USE IN TERMS OF ENERGY CONSUMPTION

- If you do not use the Water Treatment device with pump more than 3 days, turn off the device and disconnect the plug from the socket.
- Pay attention not to forget the faucet open.
- Disconnect the power to avoid both damage to the device and excessive power consumption in case the voltage is too low or too high.
- Avoid wasting your water.
- Do not place the device in direct sunlight or near heat-emitting devices.

CONSUMER APPLICATIONS FOR COMPLAINTS AND OBJECTIONS

- In case the warranty certificate is not provided by the seller, the consumer may apply to the Customs and Trade Ministry, General Directorate for Protection of the Consumer and Market Surveillance.
- Consumer may apply to the consumer arbitration board or the consumer court where the consumer resides in or the products have been purchased for the disputes that may arise in connection with the exercise of the rights arising from the warranty.

RIGHT OF CHOICE PROVIDED TO CONSUMER WITH 11th ARTICLE OF LAW

1. If the product is found defective;
 - Consumer can renege on the contract by notifying the seller that they are ready to get back the product.
 - Consumer can retain the defective product and ask for discounts at the defect rate on sales price.
 - Consumer can ask for repair free in case it does not cost much,
 - Consumer can ask for replacing the defective product with another product if possible by using right of choice. The seller is liable for fulfilling the consumer's demand.
2. Consumer can apply to the manufacturer or importer for repair or replacement of the defective product without any charge. The seller, manufacturer and importer are successively responsible for fulfilling the conditions based on the rights.
3. In the event that consumer prefers to use the right of free repair and;
 - The product re-fails during warranty period,
 - The maximum time required for repair is exceeded,
 - If repair is not possible and determined with a report by an authorized service, seller, manufacturer or importer,

Consumer may request from the seller to refund, discount at the defect rate or replace the product with non-defective products if possible.

The seller cannot refuse the consumer's demand in such situations. If this claim is not fulfilled, the seller, producer and importer are severally liable.

It is a eco-friendly, new energy saving source.

TROUBLESHOOTING

Problem	Possible Cause	Action
THE DEVICE DOES NOT WORK	No water supply	Ceek if water enters the system
	Faulty connection to power source	Check the electrical connections
	Damaged adapter	Replace it or contact service
	Faulty low pressure switch	Replace it or contact service
NO PRODUCT (PURIFIED) OR WASTE WATER FLOW	Water supply valve is closed	Open the water supply valve
	Clogged filters	Replace the clogged filters.
		Replacement of flow restrictor is recommended.
SLOW OR NO PRODUCT WATER FLOW BUT THERE IS WASTE WATER FLOW	Clogged or exhausted membrane	Replace the membrane
	Faulty check valve	Replace check valve
	Faulty storage tank	Replace the tank
TANK IS FULL BUT THERE IS WASTE WATER FLOW	Too low or high pressure	Pump should be used for water with low pressure as pressure reducer is recommended for water with high pressure.
	Faulty check valve	Replace check valve
LEAKS IN DEVICE	Faulty connection	Check all connections
	Not properly cut edges of tubes	Remove leaking tubes, cut the edges straightly and replace them.
	Not properly fitted gaskets	Fit the gaskets
UNPLEASANT ODOR AND TASTE OF PURIFIED WATER	Exhausted cartridge filters	Replace the filters if they are used up for 6 months.
	Low pH level	Ideal pH level is between 7-8. If lower, ask your service for installing a pH meter. (Not covered by warranty)
	Bacteria in the device	Disinfect your device
NO WASTE WATER FLOW	Clogged flow restrictor	Replace flow restrictor
	Filter maintenance date has expired	Replace filters and membrane element
SLOWLY FLOW OF PURIFIED WATER FRO FAUCET	Faulty storage tank	Replace the tank

FREQUENTLY ASKED QUESTIONS

“How often should filters be replaced?”

It depends on properties, quality of water supply and usage frequency of the system. It is recommended to replace filters every six months. We recommend that you replace post carbon filter cartridge once a year and membrane every three years.

“I have replaced the cartridges newly and the water is cloudy. Is it normal?”

After you have replaced the filters, you should drain the water for a few minutes. Because carbon filters are made of natural materials, cloudy black water may flow for a while (10-15 minutes), Keep your faucet open and turn off the tank valve. Allow the water to run out until the water is clear.

“I do not often use the system, does it change life span of filters and membrane?”

Replacement dates of the first three filters do not change; living organisms (microbes, bacteria) are settled in the filters during filtration. Therefore, first contact with water is deemed as beginning of replacement period. Less usage of the system affects only replacement period of membrane.

“Can I assemble the device and replace filters myself?”

Yes, you can. However, any other practise not performed by a service provider will cause the warranty to be voided. If the service is provided by an authorised personnel, the device will continue to be under warranty till the expiration date of warranty.

AUTHORIZED SERVICES AND SPARE PARTS SUPPLIERS



PWG
www.pwg.be

Euraqua
www.euraqua.com

Micron
www.micron.be

Suko
www.suko.be

Delta
www.deltawaterengineering.com



Kennet Water Ltd
www.kennetwater.co.uk

Euraqua UK
www.euraqua.co.uk

Wycombe Water Limited
www.wycombewater.co.uk

UVO3 Ltd
www.uvo3.co.uk



Alamo
www.alamowaterpoland.com



Aquina Wassertechnik GmbH
www.aquina-wassertechnik.de



Esli
www.esli.com.tr



Esli Aqualine ME
www.aqualine-me.com



Delta Water Softeners Nederland
www.dewason.nl



WaterTec
www.watertec.ch



EWT
www.ewt.fr



Purotech
www.purotech.ie



PWG Portugal
www.pwgportugal.com



PWG Angola
www.pwgangola.com



Insol
www.insolpwg.com

Grupagua
www.grupagua.com



Contact the seller, dealer, agent or representative office where you have purchased the product. The warranty period of the product is 2 (two) years. You can contact us within this period in case of any dispute, damage or defect not resulting from misuse;

WARRANTY

This document is allowed to be used by Directorate General of Consumer Protection and Market Surveillance, Republic of Turkey Customs and Trade Ministry in accordance with the Regulation of Practice Principles of warranty Certificate that is implemented by depending on Consumer Protection Law Numbered 6502

MANUFACTURER AND IMPORTER

TITLE : ES Lİ END. ÜRÜN. PAZ. SAN. ve TİC. LTD. ŞTİ. O.S.B. 1. Kısım Antalya Bul No:36 DÖŞEMEALTI /ANTALYA
TELEPHONE / FAX / E MAIL : 0 850 532 8 786 & 444 7 099 esli@esli.com.tr
AUTHORIZED SIGNATURE / STAMP

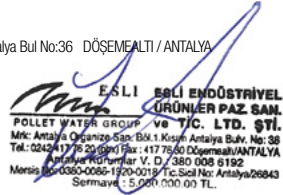

SELLER

TITLE
TELEPHONE / FAX / E MAIL
INVOICE DATE / NO
DELIVERY DATE AND LOCATION
AUTHORIZED SIGNATURE / STAMP

PRODUCT

TYPE : WATER TREATMENT DEVICE
BRAND : Pallas
MODEL : EF500 GPD, DIRECT FLOW
WARRANTY : 2 YEARS
MAX. REPAIR TIME : 20 WORK DAY
BANDEROL AND SERAL NO :

DEVICE LIFETIME: WATER TREATMENT DEVICE HAS 10 (TEN) YEARS LIFETIME. Purchased product has 2 (two) years of warranty.

TERMS OF WARRANTY

- The warranty period starts from the delivery date and is 2 years.
- Damages and defects resulting from misuse, high or low voltage, faulty electrical connection, transportation and handling after the delivery of the product and using the product contrary to the instructions specified in the users manual during the warranty period (2 years) are not covered by the warranty. Determination of technical methods for repair or replacement of parts and the parts to be replaced is the responsibility of an authorised service.
- If the consumer prefers the right of repairing the product free, the seller is liable to repair or to have it repaired without asking any charge under labour cost, cost of replaced part or any other title. The consumer may also use the free repair right against the manufacturer or importer. The seller, manufacturer and importer are severally liable for fulfilling the right of consumer.
- In the event that consumer prefers to use the right of free repair and;
 - The product re-fails during warranty period,
 - The maximum time required for repair is exceeded,
 - If repair is not possible and determined with a report by an authorized service, seller, manufacturer or importer, consumer may request from the seller to refund, discount at the defect rate or replace the product with non-defective products if possible. The seller cannot refuse the consumer's demand in such situations. If this claim is not fulfilled, the seller, producer and importer are severally liable.
- The repair period cannot exceed 20 workdays. It starts from the date of notification to an authorised service if the warranty has not expired or from the date of delivery to an authorised service if warranty has already expired. In case of not being repaired within 10 workdays, the manufacturer or importer must supply a similar product to the consumer until the product is repaired. In the event that the product is defected within warranty period, the days when the product remains in the service are added to warranty period.
- Defects resulting from contrary usage to instructions specified in users manual are not covered by the warranty.
- Consumer may apply to the consumer arbitration board or the consumer court where the consumer resides in or the products have been purchased for the disputes that may arise in connection with the exercise of the rights arising from the warranty.
- In case the warranty certificate is not provided by the seller, the consumer may apply to the Customs and Trade Ministry, Directorate General For Protection of the Consumer and Market Surveillance.

RIGHT OF CHOICE PROVIDED TO CONSUMER WITH 11th ARTICLE OF LAW

- If the product is found defective;
 - Consumer can renege on the contract by notifying the seller that they are ready to get back the product.
 - Consumer can retain the defective product and ask for discounts at the defect rate on sales price.
 - Consumer can ask for repair free in case it does not cost much.
 - Consumer can ask for replacing the defective product with another product if possible by using right of choice. The seller is obliged to fulfill this request which is preferred by the consumer.
- Consumer can apply to the manufacturer or importer for repair or replacement of the defective product without any charge. The seller, manufacturer and importer are successively responsible for fulfilling the conditions based on the rights
- If consumer refers to use the right of free repair and;
 - The product re-fails during warranty period,
 - The maximum time required for repair is exceeded,
 - If repair is not possible and determined with a report by an authorized service, seller, manufacturer or importer, Consumer may request from the seller to refund, discount at the defect rate or replace the product with non-defective products if possible. The seller cannot refuse the consumer's demand in such situations. If this claim is not fulfilled, the seller producer and importer are severally liable.

CONSUMER APPLICATIONS FOR COMPLAINTS AND OBJECTIONS

- In case the warranty certificate is not provided by the seller, the consumer may apply to the Customs and Trade Ministry, Directorate General for Protection of the Consumer and Market Surveillance.
- Consumer may apply to the consumer arbitration board or the consumer court where the consumer resides in or the products have been purchased for the disputes that may arise in connection with the exercise of rights arising from the warranty.

The product you have purchased complies with the standards of 2014/35/EU;

ESLI
Poliet Water Group



DECLARATION OF CONFORMITY

We declare that the below listed products are manufactured in full compliance to
2014/35/EU low voltage directive and 2014/30/EU
Electromagnetic Compatibility Directive.

Product : PALLAS EF500

Models : 5 STAGE, 500 GPD, HIGH FLOW WITH PUMP

Applicable CE Directives (2014/35/AB) Low Voltage Directive – 2014/30/EU Electromagnetic
Compatibility Directive

Applicable International Technical Standards:

TS EN 60730-2-15 :2011, TS EN 55014-1:2017, 55014-2:2016 TS EN 61000-3-2:2014, TS EN
61000-3-3:2014, TS EN 60335-1:2012+AC 2014+A11:204

ESLI ENDÜSTRİYEL URUNLER PAZARLAMA SANAYI VE TİCARET LIMITED SİRKETİ

Address : Antalya Organize Sanayi Bölgesi 1. Kısım Antalya Bulvarı No: 36 07190
Döşemealtı / ANTALYA TURKEY

TEL : 0 850 532 8 786 & 444 7 099

E-MAIL : esli@esli.com.tr

NOTE: Our declaration on the products will be voided due to modifications made without our consent.